

Data Sheet

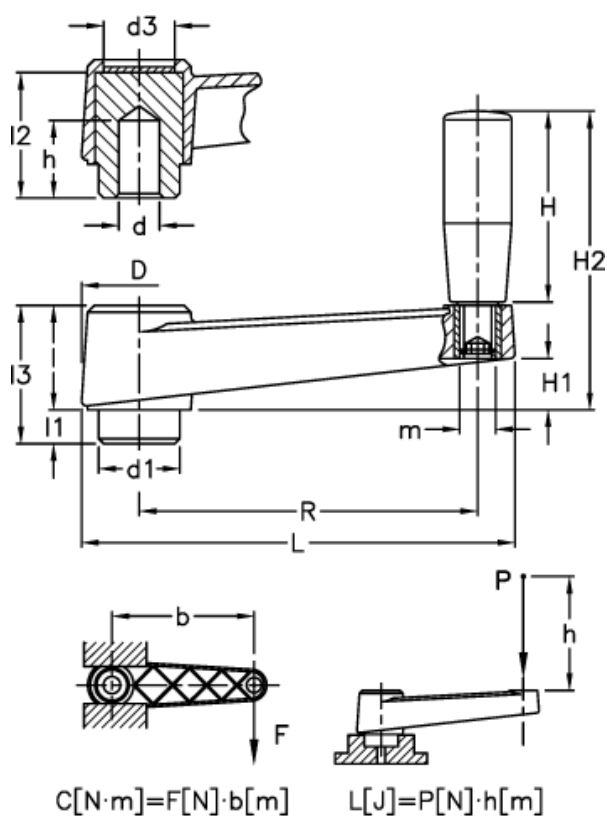

Article number: 2301044191
 Description: E+G Crank handle
 MT.80

Measures



C (N m) = 180	H2 = 76	R = 80
D = 30	l = 26	
d1 = 22	L = 105	
d3 = 17	L (J) = 15	
d H9 = 6	l1 = 10	
H = 50	l2 = 32	
h = 26	l3 = 36	
H1 = 13	m = M6	